

OCS-S1
High Resolution Digital Crane Scale

User's Guide

Content

<u>1. Safety Guide</u>	<u>1</u>
<u>2. Features</u>	<u>1</u>
<u>3. Specifications</u>	<u>2</u>
<u>4. Capacity</u>	<u>2</u>
<u>5. Dimension & Weight</u>	<u>3</u>
<u>6. Display & Keys</u>	<u>3</u>
Scale Keys.....	3
Remote Keys.....	4
Indicators	4
Message	5
<u>7. Operations</u>	<u>5</u>
Power On/Off.....	5
Zero.....	6
Tare In/Out.....	6
Lock/Unlock	6
Accumulate	6
View	7
Delete Last Weight.....	7
Clear All Weight.....	7
Unit Switch	7
<u>8. User Setup</u>	<u>7</u>
Auto-Off Timing	8
Backlight Brightness.....	8
Idle Mode Timing	8
<u>9. Battery Maintenance</u>	<u>9</u>
<u>10. Troubleshooting</u>	<u>9</u>

Version: V1.0A-2

Please read this manual carefully before using.

1. Safety Guide

For good performance and precise measurement, be careful with daily operation and maintenance.

- i** Do NOT overload scale. This will damage loadcell and void warranty.
- i** Do NOT leave load hung on the scale for long. This will decrease scale's accuracy and shorten loadcell's life.
- i** Inspect shackle and hook before using. Check clips, pins and screws regularly.
- i** Check battery frequently. When scale runs out of power, replace the dead batteries with new ones.
- i** Rotate load rather than scale if needed.
- i** Do NOT use scale under thunder or rain.
- i** Hang scale on shelf in dry and well-ventilated room. Do NOT place scale on the ground directly.
- i** Do NOT attempt to repair scale yourself. Contact your local representative.

2. Features

This scale is a combination of sound and proven mechanical design, with today's most advanced electronics to provide a superb feature set. It is versatile, reliable, accurate and easy to operate.

- ✓ Superb Quality.** Strictly in accordance with OIML R76, Chinese GB/T11883-2002 national standards, and European CE directives.
- ✓ Great Safety.** Aluminum-casting case, high firm hook and shackle, dedicated weighing loadcell for safety installation.
- ✓ Strong Reliability.** Cutting-edge technology, quality integrated

circuit for high performance and long-time stability.

- Broad Applicability.** Popular and applicable in storage, textile, metallurgy industry, and so forth.
- Complete Function.** Resolution switch, unit conversion, auto power-off, battery inspection, etc.

3. Specifications

Accuracy	Chinese GB/T 11883-2002 CIII eqv. OIML R76
Tare Range	100% F.S.
Auto Zero	±20% F.S.
Manual Zero	±4% F.S.
Stable Time	≤10sec
Overload	100% F.S. + 9e
Safety Load	120% F.S.
Ultimate Load	400% F.S.
Battery	4*AA 1.5V batteries
Battery Life	≥25hour (tested by dedicated batteries)
Display	25.4mm (1inch) ultra-bright LED
Op. Temp.	-10℃ ~ +40℃
Op. Humidity	20℃ ≤90%

4. Capacity

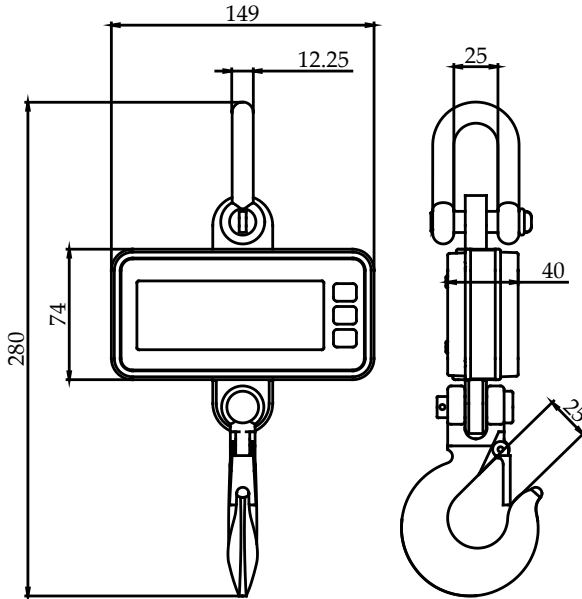

Modal	Max. Cap.	Min. Cap.	Res.	Division
OCS-01-S	100kg	1kg	0.05kg	2,000
OCS-02-S	200kg	2kg	0.1kg	2,000
OCS-03-S	300kg	2kg	0.1kg	3,000
OCS-05-S	500kg	4kg	0.2kg	2,500
OCS-1-S	1,000kg	10kg	0.5kg	2,000

5. Dimension & Weight















6. Display & Keys

Scale Keys

Key	Name	Function
	On/Off	Short pressing: Cancel & return to weighing mode Long pressing: Power-on / Power-off
	Tare	Short pressing: Tare in/out; Increase digit Long pressing: Zero; Move digit

	Hold	Short pressing: Lock/unlock; Confirm & next Long pressing: Unit Switch; Input / cancel decimal point
---	------	---

Remote Keys

Key	Name	Function
	Zero	Same as long pressing 
	Tare	Same as short pressing 
	Hold	Same as short pressing 
	Acc.	Accumulate weight Decrease flashing digit
	Del.	Delete last weight Clear all weight Left scroll flashing digit
	F1	View Input / cancel decimal point
	F2	Unit Switch
	Off	Long press to power off Return to weighing mode
	2nd	2nd function

Indicators

LED	Name	Note
STB.	Stable	lit when weight is stable
ZERO	Zero	lit when weight is at zero
TARE	Tared	lit when scale is tared





HOLD	Hold	lit when scale is locked
lb	lb	lit when unit is lb
kg	kg	lit when unit is kg

Message

Message	Stand for	Note
-----		detect weight
SETUP	SETUP	User Setup Menu
BAT99	BATtery	battery life percentage
End	END	save and exit
OFF	OFF	power off
ovEr	OVERload	overloading
Err	ERRor	invalid operation
ACC	ACCumulate	accumulate weight
dEL	DELeTe	delete last weight
CLr	CLeaR	delete all weight

7. Operations



Power On/Off

- Long press  to power-on scale. Scale perform initialization and power-on test, **88888** shows twice, then capacity **1000** shows, battery life percentage **BAT99** shows, weight detection **-----** shows and then auto zero.
-  For information about Auto-Zero, refer to Scale Configuration in Technical Manual.
- Long press  or  to power-off scale. Battery life percentage **BAT99** shows, off message **OFF** shows, and





then cut off power.

- ✎ When 3 batteries voltage is lower than 3.2V, scale will auto power-off itself. Please replace the dead batteries with new ones.





Zero

- ✓ Long press , or press , to zero. **ZERO** shows.
- ❗ If load is in motion, or tared, or out of Manual-Zero Range, **Err** shows.
- ✎ For information about Manual-Zero Range, refer to Scale Configuration in Technical Manual.

Tare In/Out

- ✓ In gross mode, press , or press , to tare in. **TARE** shows.
- ❗ If load is in motion, or negative, or out of Tare Range, **Err** shows.
- 📄 Tare will reduce the apparent overload range of scale. For example, if a 500*0.2kg scale has a 100kg container as its tare, the scale will overload at a new weight of 401.8kg (500 – 100 + additional 9 divisions).
- ✓ In net mode, press , or press , to tare out. **TARE** disappears.

Lock/Unlock

- ✓ Press  or  to lock screen. **HOLD** shows.
- ✓ Press  or  again to unlock screen. **HOLD** disappears.







Accumulate

- ✓ Press  to accumulate current weight.



 **ACC** shows, indicating weight is accumulated. Scale uses displayed weight, so gross or net weight is added into the same accumulator.

 If load is in motion, or negative, or does not return to zero before, **Err** shows.



View

- Press  to enter View mode.
-  Display flashes accumulated weight.
- Press  or  to view high 5-digit or low 5-digit.
- Press  or  to exit View mode.





Delete Last Weight

- Press  to delete last accumulated weight.
-  **dEL** shows, indicating last accumulated weight is deleted. Delete function only deletes the last weight.
-  If last accumulated weight has been deleted, **Err** shows.

Clear All Weight

- Press  first and then press  to clear all accumulated weight.
-  **CLR** shows, indicating all weight is cleared.





Unit Switch

- Long press  or press  , to switch unit in between kg, lb, and User Unit.
-  When unit is kg, **kg** shows. When unit is lb, **lb** shows.
-  For more information about User Unit, refer to Scale Configuration in Technical Manual.





8. User Setup

- ✓ Press  first and then press  or  to enter User Setup menu. **SETUP** shows.





Auto-Off Timing

- ✓ Press  or  to enter Auto-Off Timing. **OFF--** shows.
- ✓ Press  or press  or , to change timing value.
- ↪ Auto-Off Timing can be set to: **0** (disabled), **5** (5min), **10** (10min), **15** (15min), **30** (30min), **60** (60min). It is disabled by default.
- ☐ Auto-Off function maximizes scale's battery life against people's carelessness not to power off scale when it's not working.
- ☐ Auto-Off starts countdown timer when there's no action or load is stable. Any key pressing or motion in load restarts countdown timer.



Display Brightness

- ✓ Press  or  to enter Display Brightness. **br -** shows.
- ✓ Press  or press  or , to change brightness value.
- ↪ Display Brightness can be set to: **OFF** (disabled), **1** (dim), **2** (normal), **3** (bright).
- ☐ Dim display brightness saves battery power dramatically.

Idle Mode Timing





- ✓ Press  or  to enter Idle Mode Timing. **IDL--** shows.
- ✓ Press  or press  or , to change timing value.
- ↪ Idle Mode Timing can be set to: **0** (disabled), **5** (5sec), **10** (10sec), **15** (15sec), **30** (30sec), **60** (60sec). It is 30sec by

default.

- To maximize battery life, scale automatically enters Idle Mode, when there's no action or the load is stable. In Idle Mode, scale works in low-power consumption status. Any key pressing or motion in load wakes up scale from Idle Mode.
- Press  or  to exit User Setup.

9. Battery Maintenance

To maximize battery life, please note the following battery maintenance guide.

-  This scale is powered by a 4 AA 1.5V batteries.
-  Battery houses at the rear of scale can be opened by screwing off screws.
-  Depending on display brightness and idle mode setting, normally, battery works over 25 hours.
-  In order to conserve battery life, enable Auto-Off and Idle Mode, dim display brightness.
-  When 4 batteries voltage is lower than 3.5V, scale will auto power-off itself. Please replace the dead batteries with new ones.

10. Troubleshooting

Simple problems can be resolved as below listed solution. If problems still exist, please contact your local representative.

Symptom	Possible Cause	Suggested Solution
not power-on after  is pressed	discharged / defective battery	check battery and replace
	defective On/Off key	press harder and keep pressing for 2s

	defective power cable	open front panel, check power cable
	defective mainboard	contact representative
display flashes	discharged battery	replace battery
no action taken after key pressed	scale is disturbed	re-plug power cable
	defective key	contact representative
weight reading not stable	load in motion	keep load stable
	weak Anti-Motion	change Anti-Motion level
	damped loadcell or mainboard	dry loadcell or mainboard
	defective mainboard	contact representative
weight reading not zero when no load	discharged battery	replace battery
	loadcell stressed too long	hang scale in storage
	loadcell drifts	contact representative
large error in weight reading	scale not zeroed before applying load	Manual Zero scale before loading
	wrong unit	switch to correct unit
	require calibration	calibrate scale
	defective loadcell or mainboard	contact representative

